

PRICE LIST
w.e.f. 01.04.2019
Non Branded LPG Products



A Range of Non Branded LPG Burners, Valves, Regulators, Pigtails, Canteen Burners, and spare parts

High Pressure Burners

T-1 Burner



Rupees 280/-

T-2 Burner



Rupees 315/-

G-1 Burner



Rupees 350/-

G-2 Burner



Rupees 400/-

G-3 Burner



Rupees 450/-

Adapters

Adopter -Nozzle



Rupees 75/-

Adopter -Nozzle



Rupees 100/-

Adopter -3/8"

Adopter -1/2"



Rupees 100/-

Needle & Nozzle Control Valves

NCV -Light



Rupees 65/-

NCV -Medium



Rupees 85/-

NCV Long Spindle



Rupees 110/-

NV Medium



Light ~ Rupees 65/-
Medium ~ Rupees 85/-

Model-IV & Jodh Puri Burner

Model-4 Br.



Light ~ Rupees 150/-
Medium ~ Rupees 290/-
Heavy ~ Rupees 350/-

Jodh Puri Br.



0 No. ~ Rupees 190/-
1 No. ~ Rupees 250/-
2 No. ~ Rupees 320/-
3 No. ~ Rupees 490/-

Jumbo Canteen Burner

Jumbo Canteen Br.



Rupees 1250/-

Ribbon Burner with Injector Assembly

RV Br. -Light Quality



Rv Br. 2Feet ~ Rupees 460/-
 Rv Br. 3Feet ~ Rupees 575/-
 Add Rupees 40/- Extra P/F
 Add Rupees 40/- extra for Center socket

Pilot Burners



Light ~ Rupees 65/-
 Medium ~ Rupees 80/-

Burner Pigtails

Copper Br. Pigtail

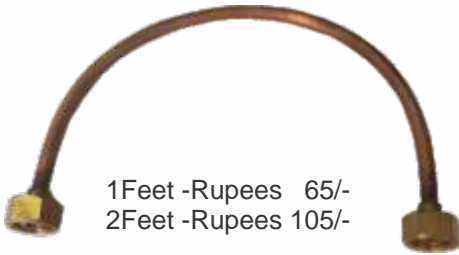

1Feet -Rupees 65/-
 2Feet -Rupees 105/-

Add Rupees 40/- Extra Per R/Feet

Wrapping Br. Pigtail

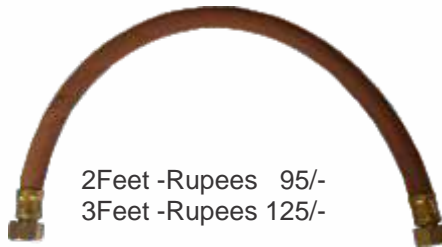

2Feet -Rupees 95/-
 3Feet -Rupees 125/-

Add Rupees 30/- Extra Per R/Feet

Flexible Br. Pigtail

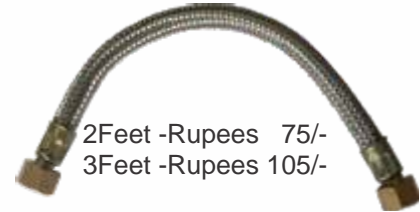

2Feet -Rupees 75/-
 3Feet -Rupees 105/-

Add Rupees 30/- Extra Per R/Feet

Cylinder Pigtails

Copper Cyl. Pigtail

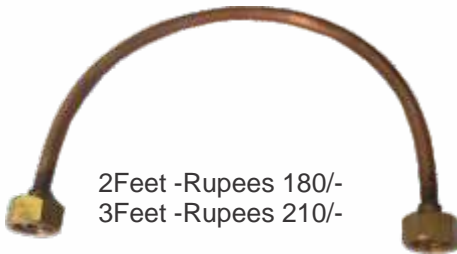

2Feet -Rupees 180/-
 3Feet -Rupees 210/-

Add Rupees 40/- Extra Per R/Feet

Wrapping Cyl. Pigtail

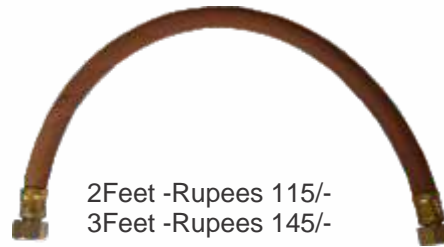

2Feet -Rupees 115/-
 3Feet -Rupees 145/-

Add Rupees 30/- Extra Per R/Feet

Flexible Cyl. Pigtail

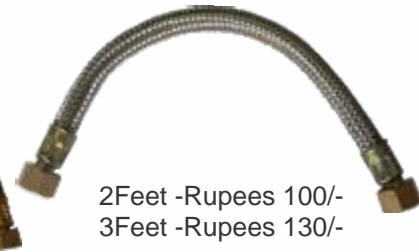

2Feet -Rupees 100/-
 3Feet -Rupees 130/-

Add Rupees 30/- Extra Per R/Feet

Pan Supports



Rupees 75/- Per Kg

Puffer Plates



Puffer Prices

| Sizes | Light | Heavy |
|-----------|-----------|------------|
| 11" x 13" | Rs. 450/- | Rs. 900/- |
| 11" x 15" | Rs. 550/- | |
| 12" x 15" | Rs. 650/- | Rs. 1100/- |
| 12" x 18" | | Rs. 1250/- |

Terminal Blocks

2 Way Ms Body



Rupees 160/-

2 Way Brass Body



Rupees 220/-

Brass Body



Rupees 80/-

Tap for Lab Burner

Chrome Tap



Rupees 60/-

Laboratory Burner

Plain



Rupees 95/-

With Tap



Rupees 120/-

Diwa For Gold Smith Use

Diwa



Rupees 210/-

Tent Burner

Tent Br.



Rupees 165/-

Industrial Regulators

Ms Body



Light ~Rupees 45/-
Med ~Rupees 55/-
Heavy ~Rupees 65/-

Brass Body



Light ~Rupees 120/-
Heavy ~Rupees 160/-

Brass Body



Light ~Rupees 95/-
Medium ~Rupees 130/-
Heavy ~Rupees 180/-

Manifold

Manifold 3x1



Manifold
MF 2 x1 ~Rupees 250/-
MF 3x1 ~Rupees 375/-
MF 4x1 ~Rupees 500/-

Extension Pipes

Zinc Pipe



Zinc Pipe
6" ~Rupees 30/-
8" ~Rupees 40/-
10" ~Rupees 50/-

Chrome Pipe



Chrome Pipe
6" ~Rupees 36/-
8" ~Rupees 48/-
10" ~Rupees 60/-

Ms Pipe



Ms Pipe
4" ~Rupees 24/-
6" ~Rupees 36/-
8" ~Rupees 48/-
12" ~Rupees 66/-

Spares Ms



| | | | | | | | |
|---|---|---|---|--|---|---|---|
| Socket | Con. Socket | St. Coupling | T - Joint | Elbow | Stop End | Stop End | Reducer |
|  |  |  |  |  |  |  |  |
| (L) ~Rs 12/- (H) ~Rs 16/- | (L) ~Rs 12/- (H) ~Rs 16/- | Rs 15/- | Rs 85/- | Rs 65/- | Rs 15/- | Rs 15/- | Rs 15/- |

Spares Ms & Brass

| | | | | | | | |
|---|---|---|---|------------------------------|------------------------------|---|---|
| Big Gully | MF Gully | DBC Gully | Nozzle Adopter | Brass Nut 1/2" | Brass Nut 3/8" | M/F | Male |
|  |  |  |  | | |  |  |
| Rupees 20/- | Rupees 20/- | Rupees 55/- | Rupees 15/- | (L) ~Rs 30/- (H) ~Rs 45/- | (L) ~Rs 15/- (H) ~Rs 25/- | Rupees 40/- | (L) ~Rs 30/- (H) ~Rs 45/- |



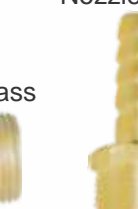
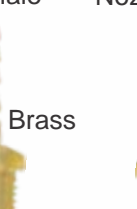



Brass Jet Body ~ 1/4 x 3/8"

Spares Ms & Brass

| | | | | | |
|---|---|---|---|--|--------------|
| Elbow | Nozzle Male | Nozzle Female | T-Joint | Y-Joint | T-Joint 3/8" |
|  |  |  |  |  | |
| Rupees 65/- | Rupees 25/- | Rupees 25/- | Rupees 15/- | Rupees 35/- | Rupees 40/- |

Labels in image: Brass, Brass, Brass, MS, Brass, Brass

Spares Brass

| | | | | | | |
|---|---|---|---|--|---|---|
| Sc 1/4" 3/8" | Sc 1/4 3/8 | St End 3/8" | St End 1/2" | Sc 3/8" 3/8" | Sc 1/4 3/8 | Sc 1/2 3/8 |
|  |  |  |  |  |  |  |
| (L) ~Rs 25/- (H) ~Rs 45/- | (L) ~Rs 25/- (H) ~Rs 45/- | Rupees 30/- | Rupees 35/- | (L) ~Rs 22/- (H) ~Rs 40/- | (L) ~Rs 30/- (H) ~Rs 45/- | (L) ~Rs 35/- (H) ~Rs 50/- |

Burner Pipes



L Shape Br. Pipe

9" ~Rs 50/-
11" ~Rs 60/-

Injector T-2



(XL)~Rs 100/-
(L) ~Rs 115/-
(M) ~Rs 145/-

Br. Pipe Chrome



Rs 40/-

Br. Stand



Rs 130/-

Spares

Clip Ms



1/2" ~Rs 13/-
3/4" ~Rs 15/-
1" ~Rs 18/-

Clip for Hose



(L) ~Rs 3/-
(H) ~Rs 8/-

Jet Plate



(L) ~Rs 20/-
(M) ~Rs 28/-

Bullet PVC Round



1" ~Rs 12/-
1.1/4" ~Rs 14/-
1.5" ~Rs 16/-

Bullet PVC Square



1" ~Rs 13/-
1.1/4" ~Rs 15/-
1.5" ~Rs 18/-

Spares

Venchury



T1~Rupees 10/-
T2~Rupees 15/-

Washers



N.C.V ~Rupees 50/- Cento
C.P.T ~Rupees 60/- Cento

Chutki Set



Ms Small ~Rupees 3.50/-
Ms Long ~Rupees 5/-

Rubber Hose Pipe



Rupees 38/- Per Meter

Gas Lighter -Commercial

Mild Steel

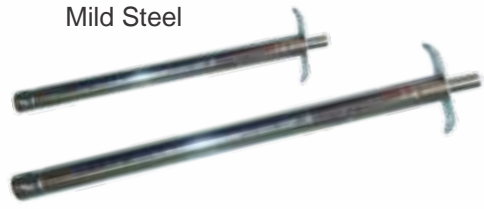

12" Long ~Rs 50/-
18" Long ~Rs 65/-

Teflon Tape



Light ~ Rupees 10/-
Medium ~ Rupees 15/-

Infra Burner



12" Long ~Rs 1100/-
21" Long ~Rs 1600/-

Mild Steel Bhatties



21"x21"x26"

Sizes ~ Wt. approx.
21"x21"x26" ~ 30KG.
24"x24"x26" ~ 35KG.

Prices of Gas Bhatti with complete fittings Rupees 140/- Per KG.



16"x16"x16"

Wt. approx. 18KG.

Mild Steel Bhatties

Double Brs. Bhatti



16"x32"x16"
Weight approx. 36KG.

Prices of Gas Bhatti with complete fittings Rupees 140/- Per KG.

Dosa Bhatti



2Feet ~Rs 3300/-
3Feet ~Rs 3850/-

Mild Steel Bhatties

Bhatti Ms~ 14"x14"x10"

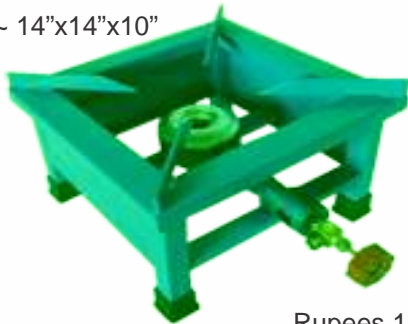

Rupees 1800/-

Bhatti Frame



Prices
Rupees 100/- Per KG

Frame Size ~ Wt. approx.
12"x12"x8" ~ 8Kg
14"x14"x8" ~ 10Kg
16"x16"x8" ~ 12Kg

Mild Steel Diesel Bhatti's

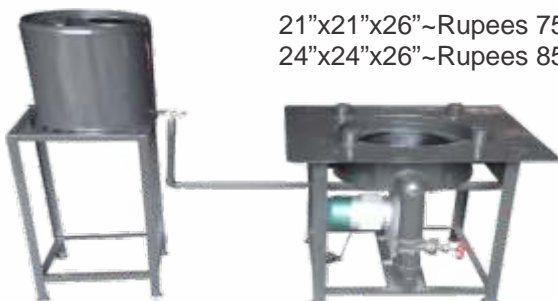

21"x21"x26"~Rupees 7500/-
24"x24"x26"~Rupees 8500/-



24"x48"x20"~Rupees 17000/-

Heating Torch with 4 No. Burner

Burners

No.0



No.3



No.4



No.5



No.6



Burner Nos. ~ Price

| | |
|----------------|-------------|
| O No. | ~ Rs. 80/- |
| 1, 2, 3, 4 No. | ~ Rs. 95/- |
| 5 No. (L) | ~ Rs.110/- |
| 5 No. (H) | ~ Rs. 225/- |
| 6 No. (L) | ~ Rs.125/- |
| 6 No. (H) | ~ Rs. 250/- |

| Gun | ~ Price |
|------------------|-------------|
| 3/4 Foot W/o Br. | ~ Rs. 275/- |
| 1 Foot W/o Br. | ~ Rs. 310/- |
| 1.5 Feet W/o Br. | ~ Rs. 340/- |
| 2 Feet W/o Br. | ~ Rs. 415/- |
| 2.5 Feet W/o Br. | ~ Rs. 450/- |
| 3 Feet W/o Br. | ~ Rs. 490/- |
| 4 Feet W/o Br. | ~ Rs. 580/- |

(Note: All prices are exclusive of Goods Sales Tax, packing, & freight charges, which will be charge as and when applicable, and are subject to change without any prior notice)

Showroom & Sales :

SARNA AGENCIES

12-13/1, Chowk Qutab Road, Sadar Bazar, Delhi-110006

Contact Person : Balwinder Singh Sarna

Call for Trade Enquiries: +91-11-23625198, 40114345, 9810536414

Email: sarnakitchensolutions@gmail.com

For "SARNA" Brand Products Log on to our Website: www.sarnaindustries.com